

VECTOR

FLASHWRITER 2

User's Manual

FLASHWRITER II BOARD

Revision 4

Manual Revision A

October 1, 1980

Copyright 1980 Vector Graphic Inc.

Copyright 1980 Vector Graphic Inc.
All rights reserved.

Disclaimer

Vector Graphic makes no representations or warranties with respect to the contents of this manual itself, whether or not the product it describes is covered by a warranty or repair agreement. Further, Vector Graphic reserves the right to revise this publication and to make changes from time to time in the content hereof without obligation of Vector Graphic to notify any person of such revision or changes, except when an agreement to the contrary exists.

Revision Numbers

The date and revision of each page herein appears at the bottom of each page. The revision letter such as A or B changes if the manual has been improved but the product itself has not been significantly modified. The date and revision on the title page corresponds to that of the page most recently revised. When the product itself is modified significantly, the product will get a new revision number, as shown on the manual's title page, and the manual will revert to revision A, as if it were treating a brand new product. THIS MANUAL SHOULD ONLY BE USED WITH THE PRODUCT(S) IDENTIFIED ON THE TITLE PAGE.

Vector Graphic Flashwriter II Board

REPAIR AGREEMENT

The Flashwriter II Board sold hereunder is sold "as is", with all faults and without any warranty, either expressed or implied, including any implied warranty of fitness for intended use or merchantability. However, the above notwithstanding, VECTOR GRAPHIC, INC., will, for a period of ninety (90) days following delivery to customer, repair or replace any Flashwriter II Board that is found to contain defects in materials or workmanship, provided:

1. Such defect in material or workmanship existed at the time the Flashwriter II Board left the VECTOR GRAPHIC, INC., factory;
2. VECTOR GRAPHIC, INC., is given notice of the precise defect claimed within ten (10) days after its discovery.
3. The Flashwriter II Board is promptly returned to VECTOR GRAPHIC, INC., at customer's expense, for examination by VECTOR GRAPHIC, INC., to confirm the alleged defect, and for subsequent repair or replacement if found to be in order.

Repair, replacement or correction of any defects in material or workmanship which are discovered after expiration of the period set forth above will be performed by VECTOR GRAPHIC, INC., at Buyer's expense, provided the Flashwriter II Board is returned, also at Buyer's expense, to VECTOR GRAPHIC, INC., for such repair, replacement or correction. In performing any repair, replacement or correction after expiration of the period set forth above, Buyer will be charged in addition to the cost of parts the then-current VECTOR GRAPHIC, INC., repair rate. At the present time the applicable rate is \$35.00 for the first hour, and \$18.00 per hour for every hour of work required thereafter. Prior to commencing any repair, replacement or correction of defects in material or workmanship discovered after expiration of the period for no-cost-to-Buyer repairs, VECTOR GRAPHIC, INC., will submit to Buyer a written estimate of the expected charges, and VECTOR GRAPHIC, INC., will not commence repair until such time as the written estimate of charges has been returned by Buyer to VECTOR GRAPHIC, INC., signed by duly authorized representative authorizing VECTOR GRAPHIC, INC., to commence with the repair work involved. VECTOR GRAPHIC, INC., shall have no obligation to repair, replace or correct any Flashwriter II Board until the written estimate has been returned with approval to proceed, and VECTOR GRAPHIC, INC., may at its option also require prepayment of the estimated repair charges prior to commencing work.

Repair Agreement void if the enclosed card is not returned to VECTOR GRAPHIC, INC. within ten (10) days of end consumer purchase.

FOREWORD

- Audience** This manual is intended for computer distributors, or others with at least a moderate technical knowledge of small computers.
- Scope** It will describe what the Flashwriter II board does in the context of a computer system, how to use the board both in Vector Graphic and in other S-100 systems, and how the board circuitry works.
- Organization** Each section is written at a uniform level of technical depth. "Perspective" describes what the board does and requires only a moderate knowledge of computer design. "Theory of Operation" discusses why the board works and assumes a knowledge of digital electronics, and "User's Guide" describes how to make the board do things and assumes the same level of knowledge, plus the ability to solder jumpers.

Vector Graphic Flashwriter II Board

TABLE OF CONTENTS

<u>Section</u>	<u>Page</u>
Repair Agreement	
Foreword	
Table of Contents	
I. Perspective	
1.1 Introduction.....	1-1
II. Theory of Operation	
2.1 Keyboard Port.....	2-1
2.2 Horizontal Sync Circuitry.....	2-1
2.3 Vertical Sync Circuitry.....	2-2
2.4 Memory Address Multiplexer.....	2-2
2.5 Memory Latch.....	2-2
2.6 Character Generator and Shift Register.....	2-3
2.7 Video Combiner.....	2-3
2.8 Monitor PROM Circuit.....	2-3
2.9 Bank Select Circuit.....	2-4
III. User's Guide	
3.1 Modifications to the Standard Configuration.....	3-1
3.1.1 Creating a New Character Set.....	3-1
3.1.2 Changing the Address of Video Memory.....	3-2
3.1.3 Putting a Monitor PROM on the Board.....	3-3
3.1.4 Address of the Monitor PROM on the Board.....	3-3
3.1.5 Specifying whether Monitor PROM on Board is 2708 or 2716.....	3-3
3.1.6 Enabling a Jump on Reset.....	3-3
3.1.7 Changing the Keyboard Port Address.....	3-4
3.1.8 Changing the Polarity of the Vertical Sync Signal.....	3-4
3.1.9 Obtaining MWRITE.....	3-4
3.1.10 Changing the Polarity of the Keyboard Strobe.....	3-4
3.1.11 Using Interrupt Driven Software.....	3-5
3.1.12 Supplying a Keyboard with a Negative Voltage Power Supply.....	3-5
3.1.13 Using a Spare Key on the Keyboard for Reset.....	3-5
3.1.14 Accessing the 60 Hz Vertical Blanking Signal.....	3-6
3.1.15 Bank Select Capabilities.....	3-6

<u>Section</u>	<u>Page</u>
3.2 Programming for the Flashwriter II Board.....	3-7
3.2.1 Vector Graphic Monitors.....	3-7
3.2.2 Displaying Characters Without Using the Vector Graphic Monitor Video Driver.....	3-8
3.2.3 Producing Reverse Video.....	3-9
3.2.4 Determining Whether a Character is in the Keyboard Buffer.....	3-9
3.2.5 Accessing the 60 Hz Vertical Blanking Signal.....	3-10
3.3 Adjusting Your TV Monitor.....	3-10
3.4 Connecting the Board to the Video Display and the Keyboard.....	3-11
3.4.1 Connecting a Video Display Requiring Separate Sync and Video.....	3-11
3.4.2 Connecting a Video Display Requiring Combined Sync and Video.....	3-12
3.4.3 Connecting a Keyboard.....	3-12
IV. Schematics and Diagrams	
4.1 Schematic Errata.....	4-1
4.2 Character Generator Patterns.....	4-2
4.3 Blank Character Generator Forms.....	4-4
4.4 Video Display Module Block Diagram.....	4-6
4.5 Component Locations.....	4-7
4.6 Schematic-Part 1.....	4-8
4.7 Schematic-Part 2.....	Foldout

Vector Graphic Flashwriter II Board

I. PERSPECTIVE

1.1 Introduction

The Flashwriter II Video Board is Vector Graphic's advanced 80 x 24 memory mapped video board. By "80 x 24" we mean that the board displays characters on the screen in 24 rows of 80 characters each. Each character is made up of an 8 x 10 matrix of dots.

The Flashwriter II can be installed in most S-100 8080 or Z-80 computer, including existing Vector Graphic computers, in order to convert the existing memory mapped display to 80 x 24, or to make use of memory mapped video for the first time if a serial terminal had been used. It can be used with almost any standard computer video monitor, since it can produce either separate or optionally combined video and sync signals. However, the monitor must have a bandwidth of at least 12 MHz. The board is definitely applicable to the Vector Graphic Mindless Terminal, which requires separate signals.

The Flashwriter II makes use of the most up-to-date ideas in circuit design such as flicker-free updating of the screen, separate sync outputs for video monitors requiring it, on-board user-programmable PROMs storing the character set, on-board socket for a video-driver and/or Monitor, Jump-on-Reset capability, to be used if the on-board video-driver socket is used, the availability of inverted or non-inverted vertical sync signals, the availability of combined or separate video and sync signals, and the capability for reverse video. To make the board adaptable to many different systems, you are free by using jumpers to specify the memory addresses used by the on-board video memory RAM and the on-board video driver.

Further, a parallel keyboard input port is incorporated on the board, with the port numbers changeable by jumper anywhere from 00 and 01 (status and data) up to 0E and 0F. Although the board is shipped jumpered so that it strobes the keyboard data into the input latch on the rising edge of the key-depression strobe, a jumper can be installed to strobe the data on the falling edge, as required by some keyboards. The board can also be jumpered to generate an interrupt when a key is depressed, instead of waiting to be polled.

A particularly useful feature of the board is the ability to accept a user-created character set, which can be either a 128 or 256 character set. If a 256 character set is desired, then the user must sacrifice the use of reverse video. The board is shipped with a 128 character set, on a PROM. This set consists of the 96 standard ASCII characters and 16 special graphics characters which can be used to build graphics images or large characters. Instructions are provided for creating your own character set and encoding it on 2708 or 2716 EPROMs (the latter for a 256 character set), if desired.

Instructions are given in this manual for writing programs to use the board. In addition, the user can purchase, if not already included in his

computer system, the Vector Graphic Extended Systems Monitor with video driver, Version 4.X EV-II. Before making this decision, section 3.2.1 should be read. Use of this Monitor will eliminate some or all of the assembly language programming necessary to use the board.

II. THEORY OF OPERATION

A block diagram of the video display module is shown in Section IV. Each of the blocks is comprised of several integrated circuits as shown on the schematic diagram in Section IV of this manual.

2.1 Keyboard Port

Starting with the keyboard port, U46 is an 8 bit latch which internally stores the data from the keyboard coming through J1 when the STB (pin 11) input goes low. A jumper option allows the correct strobe polarity to be selected. U46 contains a service request flip flop which is set by the same strobe edge that latches the data, causing INT to go low (pin 23). This signal can optionally be connected to PINT on the bus (pin 73) for interrupt driven keyboard input, or can be tested by accessing the status port. Two adjacent ports are always occupied by the status and data with the status being the lower one. The port address is decoded by U39 and the associated sections of U27 and U38. A jumper allows the selection of port addresses from 0 and 1 to E and F. (Each pair of ports refers to status and data, respectively.) Signals INPS and INPD enable tristate bus drivers U45 and U21 to gate the INT signal and data onto the bus at the appropriate time. Both inverted and non-inverted status are available, for keyboard drivers using different conventions. The vertical blanking signal is also available, from the status port, for use as a 60Hz clock signal, or for synchronizing data transfers with the vertical retrace.

2.2 Horizontal Sync Circuitry

The timing for the characters, horizontal blanking and horizontal sync pulse is provided by U15, U29, U3 and U1. A crystal oscillator at 14.318 MHz provides the clock for all the signals for the 50 Hz version of the Flashwriter II board. A crystal Oscillator at 14.3347 MHz provides the clock for all signals for the 60 Hz and Composite Video Monitor versions (See Table I of Flashwriter II schematic). This is the frequency at which the individual dots making up the characters are displayed. U15 divides this clock by 8 to generate a character clock output every time a new character is to be displayed. This signal is further divided by U29 and U3 to generate a horizontal period of 63.69 micro-seconds. The outputs H0-H6 are binary outputs representing the 80 character positions per line. H7 goes low at the end of the displayed line of characters, and is used as the horizontal blanking signal. At the count of 207, decoded by U2 pin 8, the counter string is preset to the value of 94 and starts counting over again. This signal also triggers U1, a dual one-shot to generate a horizontal sync pulse. The delay of this pulse can be varied by the horizontal position potentiometer to allow centering the display on the TV screen.

2.3 Vertical Sync Circuitry

The vertical sync counters U6, U4 and U5 are clocked by the horizontal sync pulse from U1 pin 5 to produce a count from 0 to 261. Each row of characters occupies 10 scan lines in the 60Hz version and 12 lines in the 50Hz version. The displayed characters occupy 240 lines (60Hz) and 288 lines (50Hz), and U19 pin 12 goes low at the count of 240 (288) to blank the display. A vertical sync pulse is generated by a section of U5 and U20 pin 1 which is 2 lines long, from 240(288) to 242(290). This is slightly shorter than a standard TV sync signal, and produces a minimum disturbance to the horizontal sync of the TV. The video output remains blanked until the counters are preset to 0 at the count of 261(313) for a total of 262(314) scan lines.

2.4 Memory Address Multiplexer

The on board memory is multiplexed between the CPU and the sync circuitry. This is done using tristate drivers U40, U41, U28 and the tristate outputs of U16. Thus when the CPU addresses memory, the address bus signals drive the memory address inputs, and while the characters are displayed on the screen, the address inputs are generated by the sync circuitry. One complication is that since 80 is not a binary power, there is not a convenient separation of horizontal and vertical address inputs. 80 is divisible by 16, so the least significant 4 bits from U29 are applied directly to the memory address inputs. The remaining 3 horizontal counter outputs H4-H6 and the vertical sync signals V0-V4 are mapped into 7 bits using a 256 x 8 ROM U16. This effectively maps the displayed characters in a linear fashion into the 2K of address space occupied by the memory. Since $80 \times 24 = 1920$, there are 128 locations in RAM that are not displayed on the screen.

If the memory is addressed by the CPU, it will not be able to generate the proper output to be displayed on the screen. This would cause undesirable glitches, or flashes of light on the screen as the display was being written into. To prevent this, access is inhibited by the CPU except during the horizontal retrace interval. U12 provides the necessary arbitration and pulls PRDY (pin 72) low to put the CPU in a wait state until it can access the memory. Two sections of U12 provide delays to ensure that control is transferred properly. U12 pin 13 provides a delay to ensure that the CPU has finished its current memory access cycle, and U12 pin provides a similar delay to ensure that the memory access time is satisfied before the CPU proceeds. The data bus is buffered by U44 and U33.

2.5 Memory Latch

The combined access time of the memory and the character generator ROM exceeds the character period of 558 ns. Thus the data is "pipelined" using U34 and U35 to latch the memory data. This provides 558 ns access time for both the RAM and character generator. The output of U34, U35 is delayed by one character clock period from the sync counter outputs, while the data strobed into the dot shift register U8 is delayed two character clocks. To compensate for this delay, it is necessary to delay the horizontal blanking signal also. This is done using sections of U35, and the output of pin 12 is H Blank DLD, the delayed horizontal blanking signal.

2.6 Character Generator and Shift Register

The dot patterns for each character are generated by U22 and U23. The 8 bit output from these user programmable EPROMs is supplied in parallel to U8 which shifts the dots out at the high dot clock (14.318 MHz for 50 Hz systems and 14.3347 MHz for 60 Hz systems and Composite Video Monitor) rate. The addressing of U22, 23 is arranged so that there are several options as far as the ROMs are concerned. U22 generates the top 8 lines of each character cell. If only upper case characters are used with no descenders, this is the only ROM required. For the descenders of lower case characters and graphic symbols, a second ROM is required (U23) which generates the bottom two lines of each character cell. If in addition, a full 256 characters are used, U22 is replaced with a TMS 2716. For the 128 character ASCII character set, the most significant memory bit is not required. This is normally jumpered to U7 pin 12 to control the reverse video. If the 256 character set is used, this bit is connected to U22 pin 20 to select the upper half of the ROM. More information on this subject is provided in the User's Guide, Section III of this manual.

2.7 Video Combiner

The horizontal and vertical sync signals are available at J2 pin 4,5 for monitors which require separate sync and video. U19 pin 8 is the combined video and blanking signal which is available at J2 pin 3 with the proper polarity for the Mindless Terminal. To obtain a composite video signal, consult Table 1 of the Rev. 4 schematic and change the components as indicated. With this done, the sync and video signals are combined in the circuitry associated with U10, and are available at J2 pin 1. The horizontal and vertical sync are first combined in U7 and then summed with the video using the open collector outputs of U10 and the resistive network. The resistor values have been chosen to give the proper sync and video amplitudes and to provide a 75 ohm source impedance to drive a terminated video cable. Very good video rise and fall times are obtained with this circuit. In order to compensate for the limited bandwidth of most TV monitors, some high frequency preemphasis is provided by the 470 pf capacitor shunting the 100 ohm output resistor. If the video display is not satisfactory, it may be improved by changing this value.

2.8 Monitor ROM Circuit

A socket is provided for a 2708/2716 ROM to be used as a monitor and/or video driver. U26 selects both the address for the video memory RAM and also the ROM with jumper options every 2K in the upper 16K of memory. A Jump on Reset flip flop consisting of U9 sections has two functions: 1) to disable RAM after the system is powered up or reset; 2) to enable the on-board Monitor ROM at address 0. If the first three instructions of the ROM are JMP XX03, where XX00 is the normal ROM address, then when the system is powered on or the reset key is depressed, these instructions will be executed, causing the CPU to continue executing with the 4th byte of the ROM. After the jump takes place, the circuitry automatically resets the flip flop and restores normal operation of the RAM.

Circuitry is also provided to generate MWRITE, a signal produced in some computers by the front panel. This is not required in Vector Graphic equipment as it is generated by the Z-80 CPU board.

2.9 Bank Select Circuit

A circuit to remotely bank select the refresh memory is provided for time-share systems. A cable brings the bank select signal from the 64K board to pin 1 of a connector installed in area S. The jumper between pin 1 and 2 must be cut. The bank select signal is gated by U36 with the board select signal. The board will only be selected if it is addressed by the processor, and the bank (for which the 64K board is addressed) is currently enabled.

III. USER'S GUIDE

3.1 Modifications to the Standard Configuration

The sub-sections within section 3.1 discuss each of the possible modifications which can be made to the standard Flashwriter II Board, both to its electronics and to the PROM's which support the board. In each sub-section, you will find a description of how the board is used if no modification is made, a description of why you might make the modification, and the method for carrying it out. This section should be reviewed, if only to determine what indeed constitutes the standard configuration of the board. In order to find the location of chips, jumper areas, and pads within each area, refer to the diagram on page 4-6.

3.1.1 Creating a New Character Set

The Flashwriter II Board is shipped with a standard 96 character ASCII character set plus 32 special "graphics" characters. You will find a diagram of this character set on page 4-1. The graphics characters can be used through appropriate programming to create a large variety of graphic designs on the screen. These 128 characters are those that the board displays on the video screen when the corresponding codes are stored in the on-board RAM. The code for each character consists only of 7 bits, the lower 7 bits of each stored byte. The eighth bit when set converts the character into reverse video (black on white background.) Otherwise it is normal video. Reverse video versions of the graphics characters are found on page 4-2.

The characters are stored in one 8316 2K ROM, U22. Each character consists of an 8 by 10 matrix of bits (8 by 12 for the 50Hz version), as illustrated on page 4-1. If using 2708's, PROM U22 stores the first 8 lines (lines 0 to 7) and U23 stores the last 2 (4 for 50Hz version) lines (the descender portion). The lowest addresses on U22 contain the first lines of all 128 characters, then come the second lines of all 128 characters, and so on, up to the eighth line of all 128 characters. Then U23 completes the characters with the ninth and tenth lines (ninth thru twelfth for 50 Hz version). If using 2716's, all character data is stored on the one chip.

If you wish to replace these characters, you need only create a new PROM (if using a 2716), or a pair of PROM's (if using 2708's). For a nominal fee, Vector Graphic will do this for you. You must provide Vector Graphic with a drawing of each character, darkening the appropriate cells in an 8 by 10 (8 by 12 for 50Hz version) matrix. Use the blank character form on page 4-3. Note that if you limit yourself to only upper-case characters, not using the bottom two (four for 50 Hz version) lines in each character, you will not need the U23 PROM. To order custom character PROM's from Vector Graphic, please contact the company directly to make arrangements.

You can also create a full 256 character set. To do this, you use a TMS 2716 2K x 8 PROM or equivalent for U22, and 2708 for U23. The data is organized in the same way as with a 128 character set, except that 256, instead of 128, consecutive addresses contain the first lines of all the

characters, and so on for each line in the character matrices. With a 256 character set, you sacrifice the use of reverse video, because all 8 bits of each byte are used to designate the character. Vector Graphic will also create the PROM's for you for a 256 character set, for an appropriate fee. Use both of the blank character forms found on pages 4-3 and 4-4 when sending your character set to Vector Graphic, putting the first 128 characters on the first page, and the second 128 characters on the second page.

The board is shipped jumpered for a 128 character set. Jumpers must be changed as follows for a 256 character set.

	<u>128 character set</u>	<u>256 character set</u>
Area I	2 - 1	Cut 2 - 1
Area B	2 - 4 3 - 1	2 - 1 3 - 4 Cut 2 - 4 Cut 3 - 1
Area E	1 - 3 2 - 5	1 - 3 Cut 2 - 5 2 - 4

3.1.2 Changing the Address of the Video Memory

2K of RAM are provided on-board for storage of the current screen image. Since the screen contains only 1920 character locations, the last 128 bytes of this RAM is available for any other purpose. The board is shipped with this RAM addressed at F000H. Since the Vector Graphic Extended Systems Monitor assumes this location, do not change it if you are using the video driver in this Monitor, unless you are willing to modify the Monitor on PROM. If you do want to change the address of video memory, a jumper must be changed in Area F. The jumper which determines the address of the RAM goes from pad 2 to one of the 8 pads below it. Each of the 8 pads corresponds to one address, as indicated in the diagram below. Cut the existing jumper and install a new one as required.

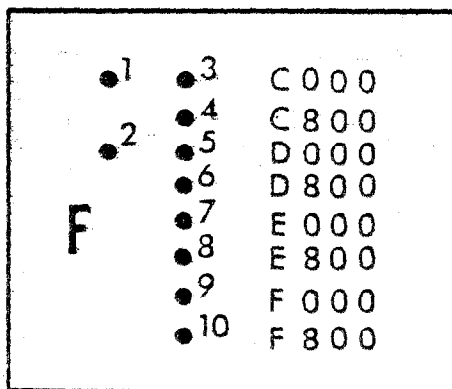

Vector Graphic Flashwriter II Board

3.1.3 Putting a Monitor PROM on the Board

The Flashwriter II board is not shipped with a Monitor PROM on the board. However, socket U42 is available for either a 1K 2708 or a 2K 2716 PROM holding a Monitor and/or video driver. If you wish to enable this on-board PROM, you must also install a 74LS244 octal buffer I.C. in location U43. It is suggested that you socket this chip. If you wish, you can write a Monitor program (see section 3.2.2.) (Note: in current Vector Graphic computers the Monitor PROM resides on the 12K PROM/RAM board or the ZCB board, not the Flashwriter II board). To operate the Monitor PROM on the Flashwriter II board in U42, the board must be properly jumpered. Refer to sections 3.1.4, 3.1.5, and 3.1.6.

3.1.4 Address of the Monitor PROM on the Board

If you choose to use the socket provided on the board for a Monitor and/or Video Driver PROM, you must put a jumper in Area F to specify the address of this PROM. The jumper goes from pad 1 to one of the 8 pads below it. Each of the 8 pads corresponds to one address, as indicated in the diagram in section 3.1.2. Obviously, you cannot use the same block of memory that is used for the on-board RAM.

3.1.5 Specifying whether Monitor PROM on Board is 2708 or 2716

If you choose to use the socket provided on the board for a Monitor and/or video driver PROM, the chip used can be either a 1K or 2K chip, i.e. a 2708 or 2716 respectively. The board is shipped to accept a 1K PROM, as determined by the jumpers in Area D. In order to use a 2716 PROM, cut the jumpers from 1 - 4 and from 2 - 3 and replace with a jumper from 1 - 3 and a jumper from 4 to Area M. (There is only one pad in Area M.)

3.1.6 Enabling Jump on Reset

At this time, the Flashwriter II board is not shipped with a Monitor PROM, and therefore is not responsible for Jump-on-Reset. If you install a PROM on the board, you will want to enable Jump-on-Reset. If this is enabled, when the operator powers on the system or depresses the front panel reset switch, the CPU will automatically read the first 3 bytes of the Monitor PROM on the board. Thus, the first three bytes of the Monitor PROM must be a jump to some other address in memory. Usually this address is simply the next address on the same PROM, namely the beginning address of the PROM plus 3.

In order to enable Jump on Reset, install a jumper in Area C from 1 - 2, and in Area K from 1 - 2. If you are writing your own Monitor PROM, then the program which begins at the 4th byte of the PROM must be an appropriate response to the reset.

3.1.7 Changing the Keyboard Port Address

Normally the keyboard is accessed through ports 00 and 01 (status and data, respectively). You can change this to any consecutive pair of ports up to 0E and 0F. This is done by changing the jumper in Area J. Cut the existing jumper. Then, install a jumper from pad 1 to the pad corresponding to the desired port address, as illustrated below.

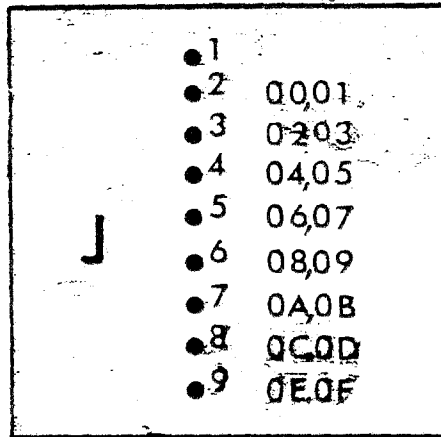

3.1.8 Changing the Polarity of Vertical Sync Signal

The board is shipped to output an inverted vertical sync signal, as required by the Vector Graphic Mindless Terminal. If you are using a video monitor which requires a non-inverted vertical sync signal, then cut the jumper in Area A from 1 - 3, and install a jumper from 1 - 2.

3.1.9 Obtaining MWRITE

The composite S-100 signal MWRITE is produced by the Vector Graphic Z-80 CPU board. In other computers, it is produced by the front panel. If your computer does not generate MWRITE, then you will need it in order to write to memory. The Flashwriter II board will generate it if you place a jumper in area G, from 1 - 2.

3.1.10 Changing the Polarity of the Keyboard Strobe

There are 4 common types of strobes generated by keyboards to indicate that a key has been depressed, as illustrated below:

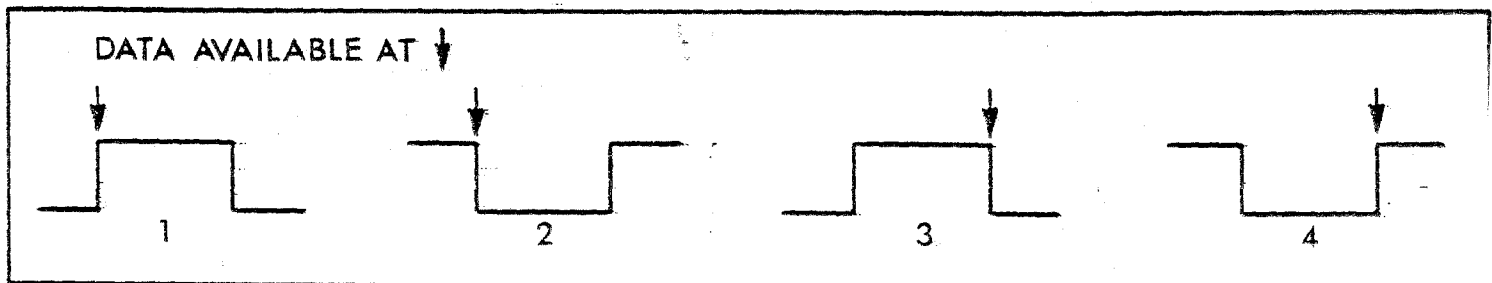

Vector Graphic Flashwriter II Board

The first type is the one used by the keyboard on the Vector Graphic Mindless Terminal. Both it and the fourth type require that the key data be strobed into the Flashwriter keyboard latch on the rising edge of the strobe. The Flashwriter II board is shipped to strobe the data into the latch on the rising edge. On the other hand, if your keyboard generates the second or third type of strobe, cut the jumper in Area H.

3.1.11 Using Interrupt Driven Software

If you want the keyboard to generate an interrupt whenever a key is depressed, put a jumper in Area L from 1 - 2. If this jumper is not in place, then keyboard data can only be obtained by polling the status port. (See section 3.2). The board may be shipped with this jumper in place.

3.1.12 Supplying a Keyboard with a Negative Voltage Power Supply

If you have a keyboard which requires a negative voltage power supply in addition to the +5V, and you are technically oriented, then there are pads in Area N of the board to install a zener regulated power supply. The circuit diagram on the left, below, will be completed if you insert the correct resistor and zener diode in Area N, as shown on the right, below.

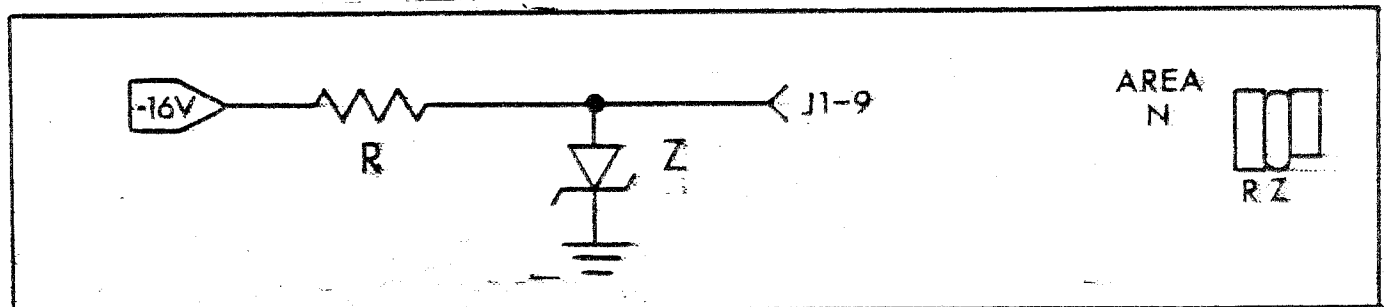

The zener diode voltage will depend on the keyboard requirements if it is needed at all, and the resistor should be selected to bias the zener diode with at least 10 mA of current in addition to the current required by the keyboard. For example, with a keyboard requiring 10 mA of current at -6V, the zener could be a IN752A (5.6V) and the resistor could be $10/.02 = 500$ ohms (470 nominal). The zener power dissipation would be 60 mw and the resistor dissipation would be 200 mw. Use a 1/2 watt resistor to allow for higher supply voltages.

3.1.13 Using a Spare Key on the Keyboard for Reset

If your keyboard has an extra key not connected to the keyboard encoder logic, it can be used to reset the system, as an alternate to the reset key on the front panel. This is not possible with the Vector Graphic Mindless Terminal. Simply connect the key so that when it is depressed it grounds pin 11 of J1, the keyboard socket. See section 3.4.3 for a diagram of J1.

This pin is connected to pin 75 on the bus (PRESET). When the line is

grounded by depressing the key, the jump-on-reset circuit on this or another board will enable the Monitor PROM on the same board.

3.1.14 Accessing the 60 Hz Vertical Blanking Signal

Bit 5 of the input status port is low during vertical retrace.

3.1.15 Bank Select Capabilities

The Flashwriter II board along with the 64K Dynamic Memory board are used for time-sharing because of their bank select capabilities. As with the 64K board, there will be one Flashwriter II board per terminal. The memory and keyboard ports on the Flashwriter boards must be jumpered as follows:

	Video Memory	Port Address	Jumper Area F	Jumper Area J		Jumper Area S
1st board	F000H	0,1	2-9	1-2	(Std jumpering)	cut
2nd board	F000H	A,B	2-9	1-7	(optional)	cut
3rd board	F000H	C,D	2-9	1-8	(optional)	cut
4th board	F000H	E,F	2-9	1-9	(optional)	cut

Cut away any pre-existing jumpers as necessary.

Vector Graphic Flashwriter II Board

3.2 Programming for the Flashwriter II Board

3.2.1 Vector Graphic Extended Systems Monitor 4.X EV-II

By far the most convenient way to use the Flashwriter II board is through the use of the Vector Graphic Extended Systems Monitor Version 4.X Option EV-II or C. There are three versions available: 4.0 monitor in 2 - 2708 PROM's, 4.0 monitor in 1 - 2716 PROM, and 4.1 monitor in 1 - 2716 PROM. If you have a PROM/RAM II board, use the 2708 version and install the PROM marked 4.0 MON, E000H, 0 in slot 8 and the PROM marked 4.0 MON, E400H, 1 in slot 9. If you are using the Vector Graphic ZCB board, you can use any of the three versions, see the ZCB manual for details. One of these monitor programs is not included with any order of the Flashwriter II board alone but are included if you purchased a complete Vector system. If you are upgrading a system from a Flashwriter I board, the Extended System Monitor used for that board will not work with Flashwriter II. You must order Monitor Version 4.0.

In the following discussion, anything that is discussed about the 4.0 Monitor or any of its options is also valid for the 4.1 Monitor. The video driver in Monitor Version 4.0 allows you to write anywhere on the screen, either by moving the cursor from the keyboard or entering X,Y coordinates from an assembly language or BASIC program. (BASIC must have POKE, as does MBASIC provided with Vector Graphic Systems.) It also allows you to toggle reverse video from program or keyboard, and offers several less significant additional features. Both Monitor Version 4.0 and earlier versions contain keyboard input routines. Option 4.0 EV-II interfaces to parallel keyboards.

In addition to the video driver, and keyboard input routines, the Version 4.0 Monitor offers a wide range of useful utility programs, including ASCII Dump, Hex Dump, Jump to Micropolis Bootstrap Loader (F800H), Compare Blocks of Memory, Find Two Bytes, Go To and Execute, Input from a Port, Jump to Loaded DOS (jumps to the warmstart location of CPM), Jump to 0000, Move Memory Block, Non-destructive Memory Test, Output to Port, Accessing Program Memory (for displaying and changing consecutive addresses), Compute Checksum, Register dump, Search for Single Byte, Test Memory, Jump to 2B00, Exchange Memory Blocks, Keyboard Echo, and Zero or Fill Memory. These routines are accessed when the Monitor Executive routine is running, as indicated by the Monitor prompt Mon>.

Version 4.0 of the Monitor contains several methods of displaying characters. Although the documentation to the Monitor describes these, a review here is useful. The basic technique is to call the video driver (CALL E009) with the desired character in the A register. This is sometimes called "sending" a character to the driver. This is the method used by all Vector Graphic operating system software such as CP/M to display characters. By itself, this can only be used to display normal alphanumeric characters, those with codes between 20 and 7F (Hex). (The driver converts the codes higher than 7F to the corresponding code from 00 to 7F, by changing the 8th bit from 1 to 0.) Then, only the codes between 20 and 7F are displayed. Any code between 00 and 1F is interpreted as a command rather than a character, or if not a valid command, then ignored.

How then are graphics characters displayed? To get around the above restrictions in order to print characters outside the range 20 to 7F, first put the character you want to print in the B register, then put Hex 05 in the A register, and then call the video driver at E009H. If the character is from 80 to FF, then it will be displayed in reverse video if your board is jumpered for reverse video as shipped. If not jumpered for reverse video and you are using a 256 character set, then codes 80 to FF will produce whatever characters are specified in the character generator PROM (see section 3.1.1.) If the character is from 00 to 1F, the corresponding graphics character will be displayed, or whatever other character is stored in the character PROM if you have created your own character set.

There is another method which is specifically used to display reverse video characters (those from 8A to FF.) First, send the character Control-T (14 Hex) to the video driver, either from program or from the keyboard via a program such as the Monitor Executive (the monitor must be in the ECHO KEYS mode first).. Following this, any character sent will be converted to the corresponding character from 80 to FF, or left in that range if already there.

Thus it will be displayed as reverse video. To cancel, send another Control-T.

3.2.2 Displaying Characters Without Using the Vector Graphic Monitor Video Driver

This section is of concern if you are bypassing the Vector Graphic Extended Systems Monitor video driver, or writing your own video driver.

To display a character somewhere on the screen, simply write the corresponding ASCII code into the appropriate RAM location, using the RAM on the Flashwriter II board. Unless you have changed the location of this RAM as described in section 3.1.2, it is the 2K block from F000H to F7FFH. Since the screen is 80 x 24, the last 128 bytes of this block are not used. The first location of this RAM corresponds to the upper left-hand corner of the screen, and successive locations move across the screen from left to right, going to the left edge of the next line down at the end of each line.

If the board is used as shipped, the characters which will be produced by each ASCII code are shown on the diagrams on pages 4-1 and 4-2. This includes special graphics characters which you can use to build graphic images such as pictures or large letters. Note that the characters from 80 to 9F are reverse video versions of those from 00 to 1F. Similarly, if you display a character having a code from A0 to FF, it will be the reverse video version of normal alphanumeric characters from 20 to 7F. (This assumes that the board is jumpered for reverse video, as shipped.) As explained in 3.1.1, you may create your own characters to replace those supplied with the board.

If you are writing your own Monitor program, including a video driver, you can if you choose install this PROM on the Flashwriter Board. The socket is labelled U42 on the board. If you do this, you should refer to sections 3.1.3, 3.1.4, and 3.1.5 in order to make appropriate hardware modifications.

Vector Graphic Flashwriter II Board

3.2.3 Producing Reverse Video

This section specifically covers reverse video, even though it has been discussed in preceding sections. Reverse video refers to displaying a character in black, on a white background. This section is only relevant if the Flashwriter Board is jumpered for reverse video, as shipped from Vector Graphic, rather than for a 256 character set. (See section 3.1.1.)

Any character stored in the Video Memory RAM will be displayed as a reverse video character if the 8th bit of the character is a 1. This corresponds to Hex codes 80 to FF. If the 8th bit is 0, i.e. codes 00 to 7F, video will be normal. In other words, if you display a character with a code between 80 and FF, it will be the reverse video version of the corresponding character between 00 and 7F. The chart on page 4-1 shows characters corresponding to 00 and 7F (Hex). On page 4-2, a number of additional graphics characters are shown having codes 80 to 9F (Hex). Notice that the graphics characters from 80 to 9F are reverse video versions of those from 00 to 1F. In the same way, if you store in video RAM the codes beyond 9F, that is A0 to FF, they will be displayed as the reverse video versions of the normal ASCII characters, having codes 20 to 7F.

There are three ways to store the reverse video characters in video memory. First, you can create the appropriate 8 bit code in a program and then store it in video RAM. For the second and third methods you must have the Vector Graphic Monitor Version 4.X.

As the second method, you can send the character Control-T (14 Hex) to the video driver. This is how the method given in the first paragraph of this section works. Control-T toggles reverse video, so that any characters sent after it, assuming they are in the displayable range, i.e. between 20 and 7F, will be displayed in reverse video (i.e. the driver will set the 8th bit.) The Control-T itself will not be displayed.

Sending a character to the video driver means putting the code in the A register and calling E009H.

Third, you can send the character Control-E (05 Hex) to the video driver. Following this, you can put any character code in register B and call E006H, and the code will be displayed. If it is in the range 80 to FF, then it will be reverse video because the 8th bit is set in these codes. Refer to the Monitor documentation for more discussion of Monitor commands.

3.2.4 Determining Whether a Character is in the Keyboard Buffer

This section is of concern if you are not using the keyboard input routine in the Vector Graphic Monitor. Bit 6 of the status port (usually port 00, unless the board is jumpered as described in section 3.1.6) is high and bit 0 is low when a character is available in the data port. You can test either one of these bits. When the test is successful, simply input the data from the data port (data port = status port + 1).

3.2.5 Accessing the Vertical Blanking Signal

For programmers interested in accessing the vertical blanking signal, bit 5 of the status port is low during vertical retrace and high at all other times.

3.3 Adjusting Your TV Monitor

If your monitor is the Mindless Terminal from Vector Graphic, then refer to the handbook for the Mindless Terminal instead of this section.

The FLASHWRITER II is designed to utilize every line of the TV raster (picture). Therefore, some adjustment of the TV monitor is usually required to make all of the characters visible on the screen. Other adjustments may also be necessary. Most monitors have the following controls, either at the rear of the set, or as in the case of the Hitachi, inside the back panel. Often times an insulated screw driver is necessary to turn the controls.

1. HEIGHT - controls the amplitude of the vertical deflection.
2. VERTICAL LINEARITY - controls the line spacing usually at the top of the picture.
3. WIDTH - controls the amplitude of the horizontal deflection.
4. CENTERING - controls the positioning of the raster on the tube.
5. HORIZONTAL HOLD - sets the frequency of the horizontal oscillator.
6. VERTICAL HOLD - sets the frequency of the vertical oscillator.
7. BRIGHTNESS - sets the background picture brightness.
8. CONTRAST - sets the video amplifier gain.

Begin the adjustment of the set with the HEIGHT and VERTICAL linearity. Fill the screen with a pattern of characters. (If you are using the Vector Graphic Extended Systems Monitor, then enter Z F000 F7FF 30 following the Monitor prompt. The missing character in the bottom line is normal - it is the cursor location.) Adjust the HEIGHT control, which is usually at the rear of the set, until all the characters fit on the screen with an adequate margin on top and bottom. Notice whether the top line of characters is exactly the same height as the bottom line. If it is not, adjust the VERTICAL LINEARITY control until it is. These controls tend to interact to some degree, so several adjustments back and forth may be necessary until a satisfactory adjustment is obtained. Do not be concerned if the display is not exactly centered from top to bottom. The HORIZONTAL HOLD should now be adjusted so that the control is in the center of the range over which the display is in sync, i.e., no characters are misshapen. For some types of displays, this may be over the whole range. At this point, the horizontal position control on the Flashwriter Board should be adjusted so that the rows of characters are centered on the screen horizontally. This control is the small black potentiometer on the upper left hand corner of the board.

Vector Graphic Flashwriter II Board

Hopefully, at this point you have satisfactorily adjusted your display. If the characters extend off the sides of the display, it will be necessary to adjust the WIDTH control. Some newer sets do not have WIDTH controls. If you are electronically oriented, you can handle this as follows: You can install a choke in series with the horizontal deflection yoke. Local radio-TV stores may be able to supply a width choke if this is necessary, or it is possible to wind one on a small powdered iron form on a cut-and-try basis. Another possibility is to slightly increase the high voltage if the set has this adjustment.

After this, if the display is not exactly centered, it may be desirable to adjust the centering rings on the deflection yoke. On the rear of the deflection yoke are two metal rings with tabs protruding from them. These rings are magnetized, and by rotating them independently, the display can be shifted in any direction up to 1/2 inch or so.

The adjustment of the BRIGHTNESS and CONTRAST should be so that the background is just barely blacked out or slightly grey, while the characters are just bright enough. Too much contrast will result in excessive overshoot on the left edges of the characters, or "hot spots" in the characters.

3.4 Connecting the Board to the Video Display and the Keyboard

This section is only relevant if the board is purchased as a separate item, not already integrated into a computer at the factory.

The 6-pin molex connector, called J2, jutting from the top left corner of the board is used to connect the board to the video display. The pins are numbered 1 to 6 from the left. Pin 1 is composite video, pin 2 is ground, pin 3 is TTL video, pin 4 is horizontal sync, and pin 5 is vertical sync. Accompanying the board in the same shipping container, you will find a small envelope containing one 6-socket molex connector, and 6 small pins that insert into it. Solder the wires of a cable of your choice onto as many pins as you need. Then, insert these pins into the sockets corresponding to the pins on J2 which you require, as described in sections 3.4.1 and 3.4.2.

As an alternate to using the enclosed 6-socket connector and assembling your own cable, Vector Graphic supplies two cables factory assembled, which you can use if one or the other meets your needs. They are described in sections 3.4.1 and 3.4.2.

3.4.1 Connecting a Video Display Requiring Separate Sync and Video

Access pins 2, 3, 4, and 5 of J2.

The cable supplied with the Vector Graphic Mindless Terminal comes with an appropriate socket attached. If you have ordered the Vector Graphic Mindless Terminal, then this cable will be enclosed with it. Use of this cable is described in the Mindless Terminal manual. You may discard the socket and insertable pins accompanying the Flashwriter II board.

3.4.2 Connecting a Video Display Requiring Combined Sync and Video

First, see table 1 on the Flashwriter II Rev. 4 schematic. Replace the components listed with the new values indicated. Rejumper as necessary. You may now access the composite video signal via pins 1 and 2 of J2. If you are using a monitor having a coaxial cable, you will probably want to assemble a cable having a compatible socket at one end, and install it in the rear of your computer, with the other end connected to J2 of the Flashwriter Board.

You can order from Vector Graphic a cable equipped with a 2-socket molex connector at one end and a BNC (circular) socket at the other end which can be installed in the rear panel of a computer. When ordering, refer to it as the "VBC" cable. Vector Graphic computers have cutouts at the rear which are the right size for this socket.

3.4.3 Connecting a Keyboard

The keyboard is connected via a 24-pin dip plug to socket J1 on the right side of the board. The following diagram shows the pin assignments:

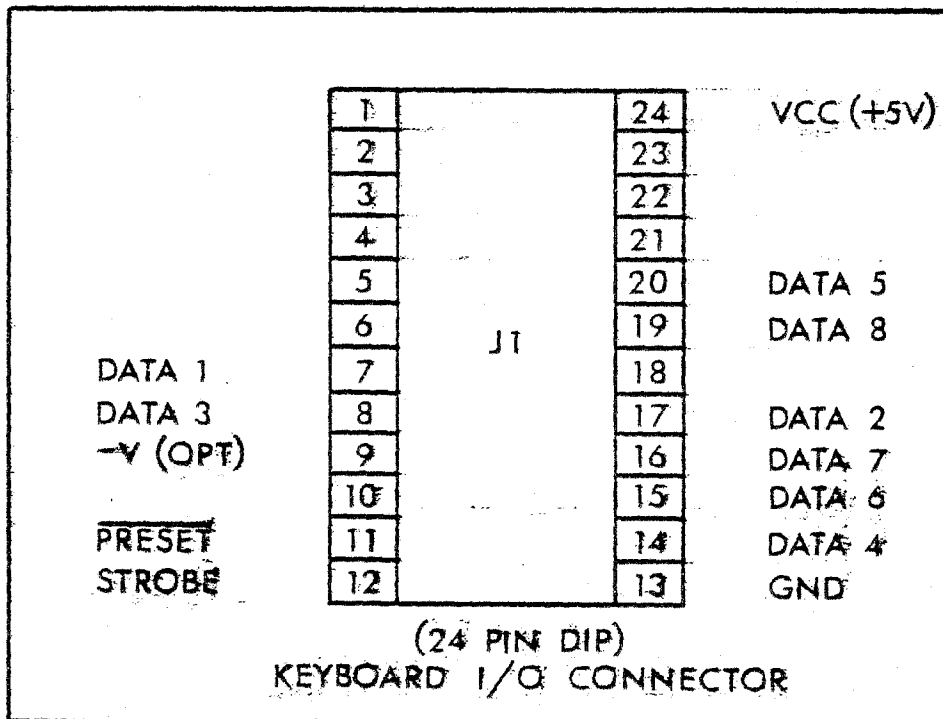

The cable shipped with the Vector Graphic Mindless Terminal has a properly wired 24-pin dip plug already attached. Simply plug it in. The use of pins 9 and 11 are discussed in sections 3.1.12 and 3.1.13.

IV. SCHEMATICS AND DIAGRAMS

4.1 Schematic Errata (11-3-80)

1. A connection is shown from U6-15 to U4-10. That should be U20-4 to U4-10. U6-15 has no connection.
2. A pull-up resistor, R 18, 680 Ohms, should be shown on Jumper Area "A", pin 1.
3. The Jumper Area to the left of R 17 is Area "I".

Vector Graphic Flashwriter II Board

Revision 4-A 10/1/80

BINARY DIGITS	HEX 1 DIGITS		D7...D0															
	4 ←	3 ←	0	1	2	3	4	5	6	7	8	9	A	B	C	D	E	F
0000	0	0	00000000	00000000	00000000	00000000	00000000	00000000	00000000	00000000	00000000	00000000	00000000	00000000	00000000	00000000	00000000	00000000
0001	0	1	00000000	00000000	00000000	00000000	00000000	00000000	00000000	00000000	00000000	00000000	00000000	00000000	00000000	00000000	00000000	00000000
0010	0	2	00000000	00000000	00000000	00000000	00000000	00000000	00000000	00000000	00000000	00000000	00000000	00000000	00000000	00000000	00000000	00000000
0011	0	3	00000000	00000000	00000000	00000000	00000000	00000000	00000000	00000000	00000000	00000000	00000000	00000000	00000000	00000000	00000000	00000000
0100	0	4	00000000	00000000	00000000	00000000	00000000	00000000	00000000	00000000	00000000	00000000	00000000	00000000	00000000	00000000	00000000	00000000
0101	0	5	00000000	00000000	00000000	00000000	00000000	00000000	00000000	00000000	00000000	00000000	00000000	00000000	00000000	00000000	00000000	00000000
0110	0	6	00000000	00000000	00000000	00000000	00000000	00000000	00000000	00000000	00000000	00000000	00000000	00000000	00000000	00000000	00000000	00000000
0111	0	7	00000000	00000000	00000000	00000000	00000000	00000000	00000000	00000000	00000000	00000000	00000000	00000000	00000000	00000000	00000000	00000000

Vector Graphic Flashwriter II Board

Revision 4-A 10/1/80

8TH BIT IS SET

BINARY DIGITS	HEX 1 DIGITS	D7...D0	D7...D0	D7...D0	D7...D0	D7...D0	D7...D0	D7...D0	D7...D0	D7...D0	D7...D0	D7...D0	D7...D0	D7...D0	D7...D0	D7...D0	D7...D0	D7...D0	D7...D0	D7...D0
4 3 2 1 0	4 3 2 1 0	0 0 0 0 0	0 0 0 0 0	0 0 0 0 0	0 0 0 0 0	0 0 0 0 0	0 0 0 0 0	0 0 0 0 0	0 0 0 0 0	0 0 0 0 0	0 0 0 0 0	0 0 0 0 0	0 0 0 0 0	0 0 0 0 0	0 0 0 0 0	0 0 0 0 0	0 0 0 0 0	0 0 0 0 0	0 0 0 0 0	0 0 0 0 0
1000	8	0 0 0 0	0 0 0 0	0 0 0 0	0 0 0 0	0 0 0 0	0 0 0 0	0 0 0 0	0 0 0 0	0 0 0 0	0 0 0 0	0 0 0 0	0 0 0 0	0 0 0 0	0 0 0 0	0 0 0 0	0 0 0 0	0 0 0 0	0 0 0 0	0 0 0 0
1001	9	0 0 0 1	0 0 0 1	0 0 0 1	0 0 0 1	0 0 0 1	0 0 0 1	0 0 0 1	0 0 0 1	0 0 0 1	0 0 0 1	0 0 0 1	0 0 0 1	0 0 0 1	0 0 0 1	0 0 0 1	0 0 0 1	0 0 0 1	0 0 0 1	0 0 0 1
1010	A	0 0 1 0	0 0 1 0	0 0 1 0	0 0 1 0	0 0 1 0	0 0 1 0	0 0 1 0	0 0 1 0	0 0 1 0	0 0 1 0	0 0 1 0	0 0 1 0	0 0 1 0	0 0 1 0	0 0 1 0	0 0 1 0	0 0 1 0	0 0 1 0	0 0 1 0
1011	B	0 0 1 1	0 0 1 1	0 0 1 1	0 0 1 1	0 0 1 1	0 0 1 1	0 0 1 1	0 0 1 1	0 0 1 1	0 0 1 1	0 0 1 1	0 0 1 1	0 0 1 1	0 0 1 1	0 0 1 1	0 0 1 1	0 0 1 1	0 0 1 1	0 0 1 1
1100	C	0 1 0 0	0 1 0 0	0 1 0 0	0 1 0 0	0 1 0 0	0 1 0 0	0 1 0 0	0 1 0 0	0 1 0 0	0 1 0 0	0 1 0 0	0 1 0 0	0 1 0 0	0 1 0 0	0 1 0 0	0 1 0 0	0 1 0 0	0 1 0 0	0 1 0 0
1100	D	0 1 0 1	0 1 0 1	0 1 0 1	0 1 0 1	0 1 0 1	0 1 0 1	0 1 0 1	0 1 0 1	0 1 0 1	0 1 0 1	0 1 0 1	0 1 0 1	0 1 0 1	0 1 0 1	0 1 0 1	0 1 0 1	0 1 0 1	0 1 0 1	0 1 0 1
1110	E	0 1 1 0	0 1 1 0	0 1 1 0	0 1 1 0	0 1 1 0	0 1 1 0	0 1 1 0	0 1 1 0	0 1 1 0	0 1 1 0	0 1 1 0	0 1 1 0	0 1 1 0	0 1 1 0	0 1 1 0	0 1 1 0	0 1 1 0	0 1 1 0	0 1 1 0
1111	F	0 1 1 1	0 1 1 1	0 1 1 1	0 1 1 1	0 1 1 1	0 1 1 1	0 1 1 1	0 1 1 1	0 1 1 1	0 1 1 1	0 1 1 1	0 1 1 1	0 1 1 1	0 1 1 1	0 1 1 1	0 1 1 1	0 1 1 1	0 1 1 1	0 1 1 1

* REVERSE VIDEO VERSIONS OF GRAPHICS CHARACTERS
 ** REVERSE VIDEO VERSIONS OF ASCII CHARACTERS

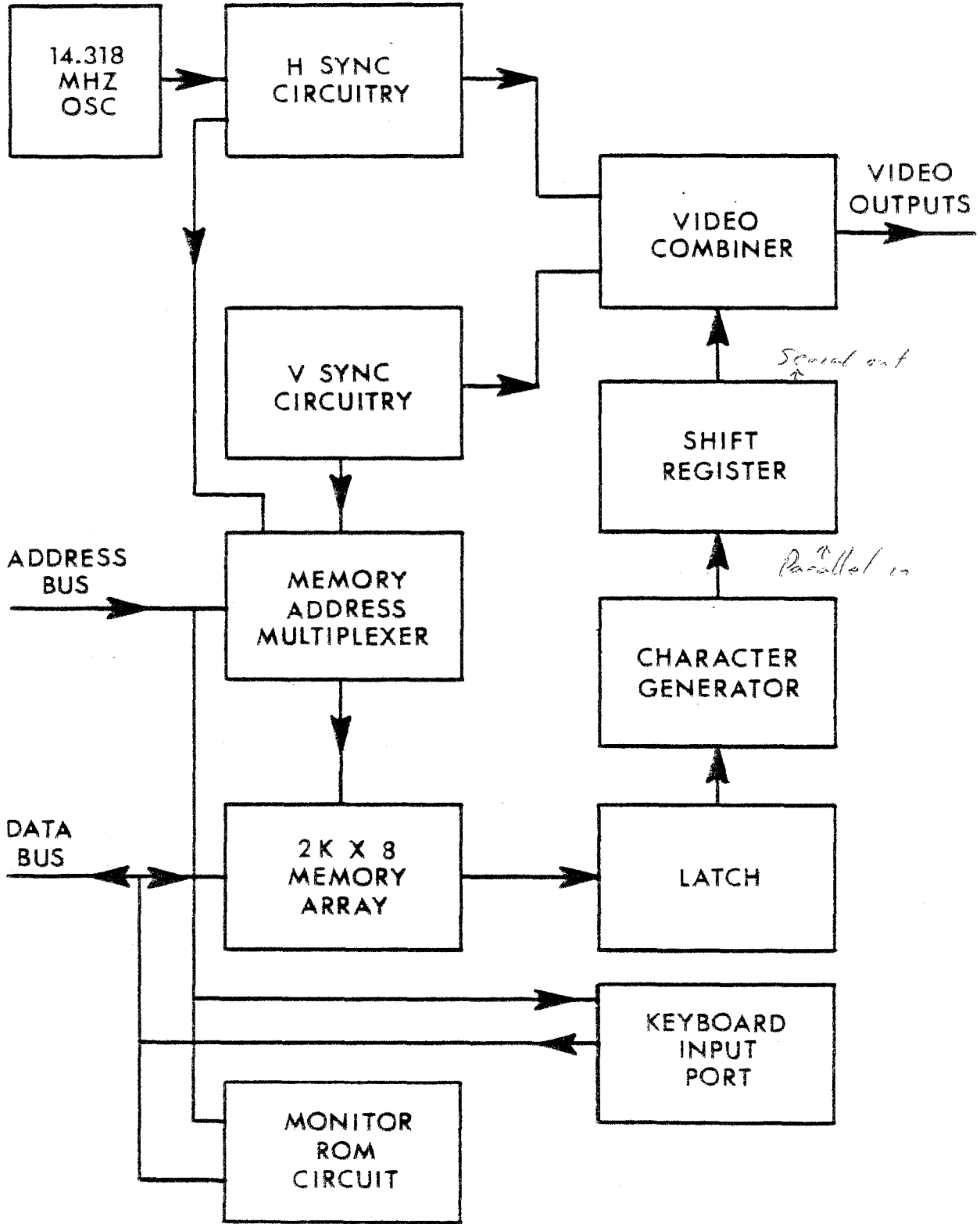

80 X 24 VIDEO DISPLAY MODULE BLOCK DIAGRAM

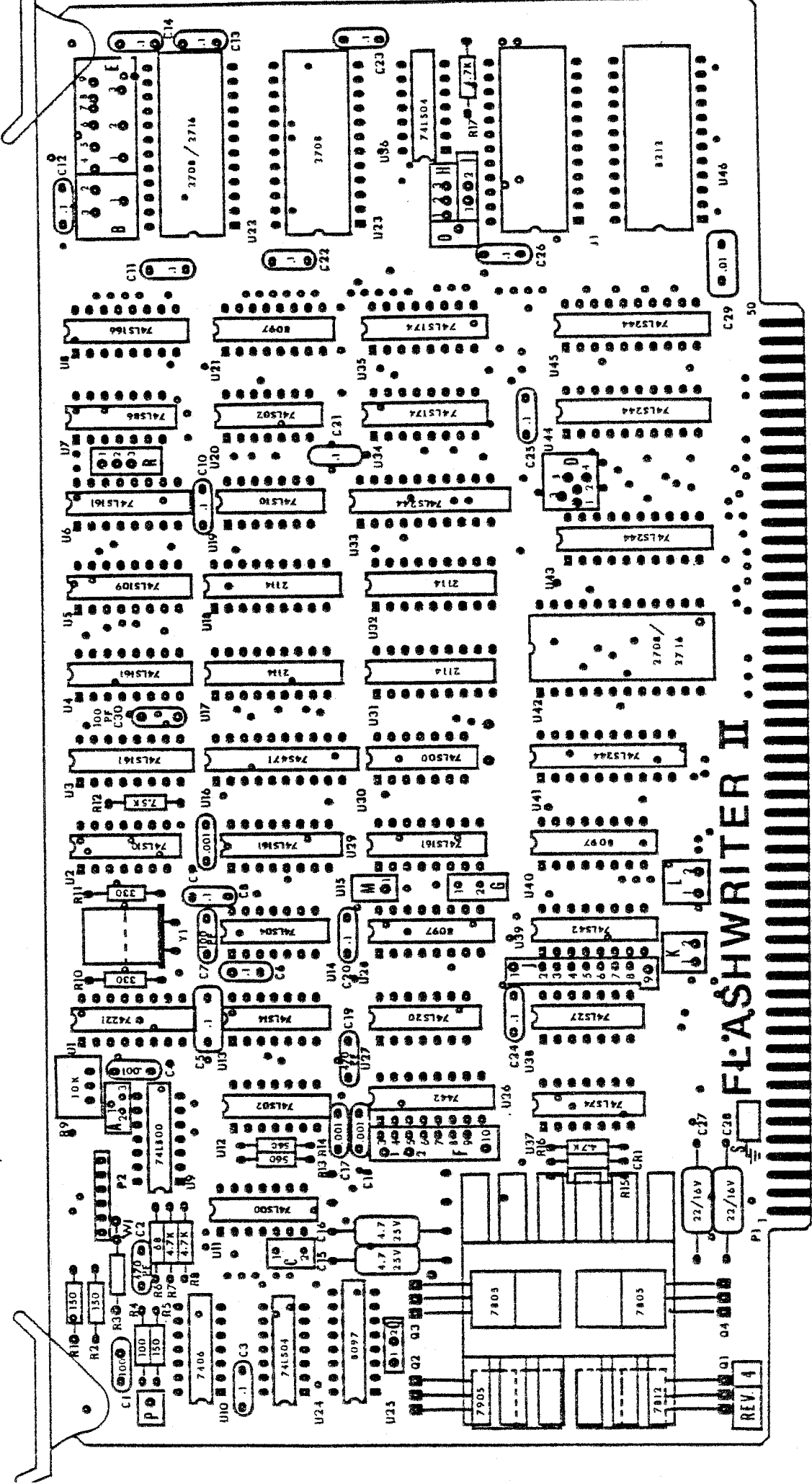

NOTES:
 1. CAPACITOR VALUES IN MICRO FARADS
 2. RESISTOR VALUES IN OHMS

SILKSCREEN
 80 X 24 DISPLAY BOARD

OWN BY:	ARTMASTER
DESIGN SERVICES:	VECTOR GRAPHIC INC.
DATE:	31364 VIA COLINAS WESTLAKE VILLAGE
APD BY:	TITLE: 80 X 24 VIDEO DISPLAY BOA
SHEET:	ASSEMBLY DRAWING
	DWG. NO.
	1 OF 1

